

TechMatch

AGRI BUSINESS & ENVIRONMENT

08

2011

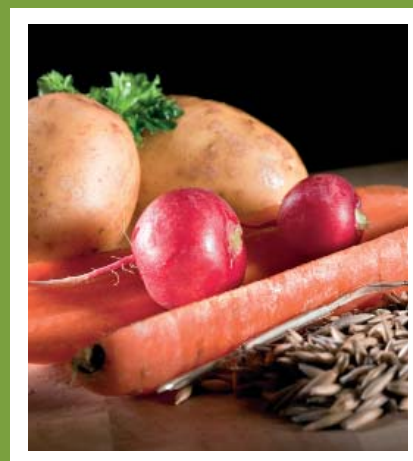
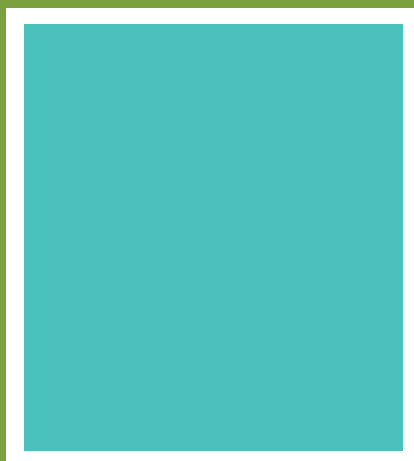
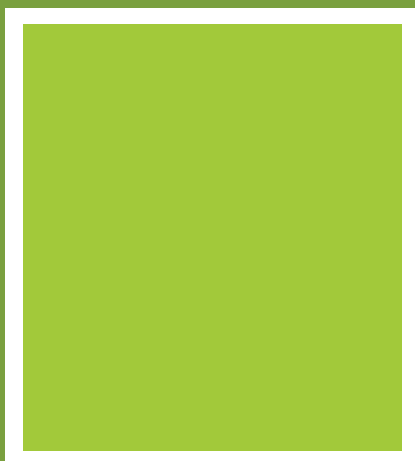
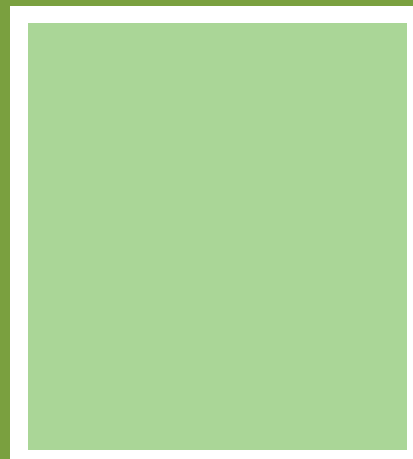

Riga Food 2011

Energy is Future 2011

SPACE 2011 - Livestock

ANUGA Matchmaking

Technology Searches

- Alternative distillation materials for beer production process
- Innovative product that transforms any grow bag to give improved plant growth
- Floating Ecological Passive Construction Systems
- Central heating boiler body welding



MAKE CONTACT WITH TECH MATCH

Make new contacts with TechMatch

TechMatch is a free information service, which includes a selection of technologies which are offered and requested by companies in Europe. The service also provides information on relevant fairs and matchmaking events.

The aim of the publication is to promote cross border trade and co-operation.

TechMatch is produced by Nordic members of the Enterprise Europe Network – the world's largest business network.

Interested in a new technology?

If you're interested in one of the technologies or events, or wish to get in contact with one of the companies in TechMatch, please contact one of our consultants. Remember to quote the reference number!

You are also welcome to contact us if you wish to promote your new technology in other European regions.



Iceland



Kristín Halldórsdóttir

Innovation Center Iceland
Reykjavik, Iceland
Tel: +354 522 9232
kristinh@nmi.is

Finland



Arttu Kotilainen

Hermia Yrityskehitys Oy
Tampere, Finland
Tel: +358 50 310 0028
arttu.kotilainen@hbd.fi

Sweden



Ellen Carlsson

Swerea SWECAST
Jönköping, Sweden
Tel: +46 3630 1246
ellen.carlsson@swerea.se

Norway



Ingrid Martenson Bortne

Innovasjon Norge
Narvik, Norway
Tel: +47 76 95 55 40
ingrid.martenson.bortne@innovasjon Norge.no

Denmark



Anne-Luise Skov Jensen

Agro Business Park
Tjele, Denmark
Tel: +45 8999 2526
alsj@agropark.dk

Denmark



Anders Skeem

Agro Business Park
Tjele, Denmark
Tel: +45 4030 9637
as@agropark.dk

A large, white, stylized letter 'E' is centered on the page. The letter is composed of thick, solid white bars. The top and bottom horizontal bars are the longest, while the middle horizontal bar is shorter. The vertical bar on the left is also thick and solid white.

TECHNOLOGY SEARCHES

New functional food additives for non-alcoholic beverages manufacturing

(Ref: 11 PL 63AV 3LMM)

Polish company - producer of bottled water and non-alcoholic beverages is looking for new products on the basis of modern functional food additives. Both samples and technological application instructions in the range of requested functional additive are requested. The company is interested in collaboration on the basis of technical or manufacturing agreement.

Modified Atmospheric Packaging Technology for Different Kinds of Food on the Same Serving

(Ref: 11 TR 99PB 3M56)

A Turkish company, interested in modified atmospheric packaging (MAP), is looking for a novel technology and/or know-how for packing of different types of food products on the same serving plate under modified atmosphere. The sought technology can either be a new process or a certain methodology for MAP, but must already be on the market. The company is open to different kinds of agreements such as licensing, technical cooperation and manufacturing agreements together with technical assistance.

PS - FP7: The role of health-related symbols and claims used in the labels and packagings of Food & Beverage Products in consumer behaviour

(Ref: 11 ES 27F4 3M54)

An Andalusian research center is looking for partners for a joint research project focused on the effect of health-related symbols and claims used in the labels and packagings of Food & Beverage Products. The center aims to provide scientific evidence on how the messages provided by this industry in relation to health, have an effect on the final consumer choice. Research fields required in the partner sought are: behavioural, cognitive research; semiotic and food & beverage labeling legislation.

Consumer products that help to maintain and improve health through food and drink

(Ref: 11 GB 41n7 3M8B)

A Turkish company, active in seafood market, is looking for individual quick freezing machine (IQF) for its seafood products namely; silver fish, anchovy and venus gallina (kind of clam). The sought technology must be fully developed and should utilize ammonia as a coolant instead of freon. The firm is open to commercial agreement with technical assistance for appropriate design of such machine for the said products, including the services of assembling, maintenance and technical consultancy.

Altered expression of DELLA protein or orthologous to alter the growth pattern of plant and metabolite content of the fruit

(Ref: 11 ES 23C6 3LU6)

A Spanish public research organization has a new invention related to the development of plants, with an altered expression pattern of DELLA or orthologous proteins, in which the normal growth pattern of the plant has been modified as well as the fruit content of volatile compounds. The invention is focused on tomato but can be applied to other species of interest. Vegetable plant breeding companies are sought for license and/or cooperation agreements.

Diet supplements - meat dipeptides in food products, R&D and commercial partner needed

(Ref: 10 PL 63AU 3JVO)

A polish university has developed a modification of the production process of meat extract (bouillon) of higher level of carnosine type bioactive dipeptides and formulas of meat products and concentrates of increased content of natural antioxidants. Furthermore, it plans to develop products similar to dietary supplements, including a complex of dipeptides with zinc and meat industry additives. R&D partner as well as commercial Partner is sought to support further steps of this development.

Alternative distillation materials for beer production process

(Ref: 10 PL 63AU 3JVM)

The offer is meant for the malting and beer distilling industry, represented by small and medium breweries which are willing to enrich their offer with unconventional products. The entity (University from Poland) has developed a large variety of unconventional "flavours" with the use of cereal and now would like to license it (e.g. rye grain, triticale, spelt, buckwheat, oat). These materials either malted or not may be applied for production of beer of interesting taste and pro-health drinks.

Novel carbohydrate technology as gut health product

(Ref: 11 GB 46P4 3LUB)

A British company based in Glasgow, dedicated to the creation of nutritional, clinical nutrition and drug delivery systems based on carbohydrates, has developed a novel carbohydrate system with different applications in gut health. The company has extensive expertise in carbohydrates and is seeking partners in pharmaceuticals, consumer healthcare etc to exploit this novel technology under license or joint venture in specific fields.

Specialized machine for flour and crude processing

(Ref: 11 SK 69CU 3LST)

A Slovak SME from the sector of food industry is looking for innovative machine for processing of flour and crude that should be easy to use and suitable for large amounts of input material. The company is searching for partners through technology transfer with technical assistance.

PS : FP7 KBBE 2012 6- Optifel: Optimised food products for the elderly

(Ref: 11 FR 35K7 3M34)

A French National Research Institute in collaboration with other partners is preparing a proposal that will be submitted in the frame of FP7 KBBE.2012.2.3.04 "personalised approaches to food production and distribution". The French leader is looking for partners such as SMEs and Academics for different types of collaboration, described in Technical Specifications field.

Technology for obtaining food fiber and cellulose from recycling of beet pulp

(Ref: 11 RU 86FG 3LRL)

A small company from Kazan, Russia, developed a new technology for producing food fiber and technical cellulose from recycling of beet pulp. The main advantages are: a new method of treating the raw materials and use of low-cost reagents. The company is looking for a partner for further joint research and testing the new technology.

Microorganisms detection system in edible fruits and vegetables

(Ref: 11 ES 23C6 3LJF)

A Spanish public research agency has developed a technology to detect microorganisms responsible for spoilage of edible fruits and vegetables which includes the detection system and the application method. It enables the improvement of the safety and quality of the products. The method is efficient, sensitive and results are obtained in a short time. Companies designing and developing equipment for fruit and vegetable processing are sought for patent licensing and/or cooperation agreements.

New generation, innovative fruit and vegetable cup sorting machines

(Ref: 11 IL 80ER 3LTG)

An Israeli manufacturer specializing in the manufacturing of turnkey solutions for the handling of fruits and vegetables has developed a new generation of cup sorters with the most advanced management interface available that is adaptable, fast and includes a taste of the art vision system compatible with almost all fruits and vegetables. The company is looking for partners to further develop the product, test new applications or enter a joint venture.

Innovative technology and product for crop and food protection against mold formation

(Ref: 11 RU 86FG 3LXM)

A small innovative company from Kazan has developed a technology and enzymatic agent of fungicidal activity for crop and food protection against mold formation. Encapsulated enzyme complex is stable over a long period of time, highly-active, completely safe for humans, animals and crops. It allows storing products in bulk. The company is interested in technical cooperation and/or joint venture.

Thermal pump installation with enhanced functional capacity for heat-and-moisture processing of foodstuff

(Ref: 11 RU 86FG 3LXZ)

A Russian institute from Kemerovo developed a design scheme of a thermal pump installation with increased functional capacity for application in the food-processing industry. The scheme allows the maintaining of the temperature and humidity indoors simultaneously, thus receiving a product with better quality and uniform distribution of moisture over the volume of the product. The institute seeks partners for further joint development.

Expertise on development and production of emulsions of essential fatty acids

(Ref: 11 NL 60AH 3LSW)

A Dutch company, specialized in the production and marketing of oils rich in essential fatty acids, is looking for a partner that has the expertise and production facilities to develop stable food grade emulsions of essential fatty acids. The company is interested in commercial agreements with technical assistance with industrial partners that have in house R&D and laboratory facilities and are also able to scale up production.

Technology for production of bio-active substances from egg white designated for food preservation, and cosmetics available for licensing

(Ref: 10 PL 63AU 3JZX)

The Polish University Research Team has developed technology for production of bioactive substances from egg white. During the process some valuable bioactive substances can be isolated e.g. lysozyme, cystatin, ovoinhibitor. These substances may be isolated separately or as preparations of variable concentration. The preparations have anti-microbe features and may be applied for food preservation and especially in cosmetics industry.

Technology for production of low-fat chips/crisps

(Ref: 10 PL 63AU 3JVL)

A Polish University from Lower Silesia region (Wroclaw) offers a technology to produce fried chips with low fat content. The process includes potato pulp dipping in a mixture of enzymes and oil frying. Lower fat content makes fried chips less caloric, this as a result will assist their approval by consumers, thus increasing demand for this product. Companies interested in licensing the technology sought.

AGRICULTURE & ENVIRONMENT

Integrated system for continuous environmental monitoring

(Ref: 11 GR 49R2 3LXT)

Greek company active in the field of land use and urban planning offers a complete integrated system for continuous environmental monitoring. The system provides a number of services such as land use, water resources, environmental prosperity monitoring and surveillance. The company is interested to conclude a technical cooperation, manufacturing agreement or commercial agreement with technical assistance with companies active in crisis management, safety, civil and environmental protection.

Innovative product that transforms any grow bag to give improved plant growth

(Ref: 11 GB 41n7 3LT2)

A UK company offers a novel support frame that turns a grow bag on its side. Manufactured from recycled galvanised steel wire the patented design ensures maximum soil depth for improved plant growth, easier watering, plus vertical plant support. It even allows the grow bag to be moved while planted. Already on the market with great reviews, the product is supplied flat packed for easy self assembly. The company is seeking additional companies active in the horticulture market.



Biofilm process to treat industrial effluents containing up to 150 g/L salt

(Ref: 11 DE 0855 3M24)

A small German company specialised in environmental biotechnology is devising a solution to treat highly saline waste water, e.g. from chemical or food processing industry. The treatment is based on biofilm technology and an adsorbing carrier material. Tests in a pilot plant show better results than conventional methods. Partners from industry and waste water treatment are sought to scale up the technology and bring it to the market.

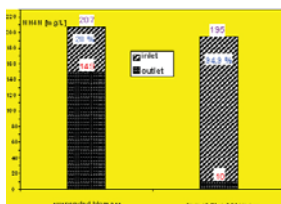

Adsorbent not based on activated carbon, suitable for removal of one or more organic substances

(Ref: 11 DE 1169 3LQT)

A German SME, with main activity in the treatment of water and waste water is looking for any kind of adsorbent not based on activated carbon. They are looking for a joint further development, testing of new applications, or adaptation to specific needs.

Innovative technology for wet feed supplements from amaranth grass meal

(Ref: 11 RU 86FG 3LPK)

A small innovative company from Kazan, Russia, developed an industrial technology for obtaining thick extracts from amaranth grass meal (the output in terms of thick extract up to 250 l/hr). The main innovation is the original integrated mechanical-acoustic chipper-extractor with high performance and mild extraction conditions. The company is looking for a partner for a joint venture or commercial agreements with technical assistance.

Low-cost fibre spraying module for horticulture, landscaping and renaturation, stationary or mobile

(Ref: 11 DE 094I 3LRI)

A German medium-sized enterprise from the machine tools sector has developed a low-cost technology for horticulture, landscaping and renaturation with three steps: Mixing - wetting - blow-down of the fibres onto the requested surface. Substrates can be sprayed on the soil via a patented procedure. The company seeks industrial partners to find out new application fields and cooperation. A license agreement is also welcome.



Renewable energy production in pond aquaculture facility: use of the hydraulic jump

(Ref: 11 ES 27F4 3LSA)

An Andalusian organization working in the aquaculture sector is seeking an innovative technology in order to use an hydraulic jump as a sustainable energy source, with the aim of covering most part of the energy demand of the facility. This organization is interested in signing a cooperation agreement with other companies or research centres in order to develop this technology at a pilot scale.

The technology of a pyrolysis carbonizing apparatus for waste materials disposal

(Ref: 11 KR 9A9E 3LZT)

A Korean SME has developed a new technology of a pyrolysis carbonizing apparatus to dispose of waste materials quickly. Technology is a device to dispose waste products such as industry residuals and wasted leads by utilizing process of a pyrolysis carbonizing apparatus. It recovers combustible energy and recycles it. The company is interested in license agreement, joint venture, and finance resources.



AGRICULTURE & ENVIRONMENT

Plannable, dry feed-based intensive farming of zander

(Ref: 11 HU 50S0 3LMT)

A new fish farming technology relying on dry feed has been developed by a Hungarian SME for the farming of zander. This revolutionary technology is both plannable and intensive, which makes it highly suitable for implementation in water farms as well as fishponds. The company is now looking for a partner for the adaptation of the technology for wels catfish farming, for the construction of an enlarged research facility and the procurement of all required equipment.

Zero emission pyrolysis processing for recycling of natural Phosphorous and Nitrogen from food grade bone meal and animal manure

(Ref: 11 HU 5010 3M40)

A Hungarian SME has developed a new, 3R (Recycle-Reuse-Reduce) zero emission pyrolysis technology that is providing added value recycling of food grade animal bonemeal and low moisture content manure from herbivorous animals. It can be converted into refined biooil, high P content bonechar/biochar natural fertilizer and liquid Nitrogen fertilizer. Cooperation partners for full scale industrial adaptation of the technology and for licence agreement are awaited.

Eco-friendly bio-pesticides with natural extracts

(Ref: 11 KR 9A9E 3M7G)

A Korean SME has developed eco-friendly bio-pesticide using natural enemy, microorganism, and natural extracts. The technology eradicates harmful insects and helps cultivation of crops by using

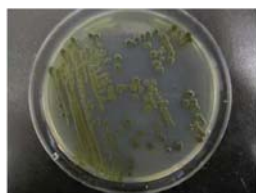

nematode which is natural enemies of pests. Its pest control is three times as effective as existing pesticides at the same price range per acreage. It is very economical due to 80~90% of nematode culture success. The company is looking for licensing agreement, joint venture, and financial resources.

A laboratory integrated into the forest measuring the impact of climate change on the forest ecosystem

(Ref: 11 FR 32j3 3M4F)

Researchers of the unit of a French National Institute specialized in agronomy are conceiving an exceptional equipment at worldwide level to determine the impact of future changes on the forest ecosystem, such as climate as well as the intensification of the harvest of small wood feeding the bio-energy sector. At the moment, the scientists are looking for partners, professional bodies and / or industrial, susceptible to be interested in technical cooperation or commercial agreement.

Pyrolysis Plant Equipment

(Ref: 11 GB 77dz 3M38)

A south west UK SME has developed innovative waste recycling plant equipment. They now seek a collaboration with a supplier and developer of Pyrolysis plant equipment to explore the development of a combination plant with glass recycling equipment. The SME seeks collaboration as either a commercial agreement, technical cooperation, or joint venture

Technology of ground and water environment reclamation by using bacteria strains

(Ref: 11 PL 64BH 3M6K)

The company from south-east Poland offers ground and water environment purification from pollutants like oil derived substances. In this field the company applies proven biotechnological methods for ground and water environment purification. The company is looking for industrial partners interested in further development and in research institutes and companies for testing of new applications. Commercial agreement with technical support is sought.

Wastewater treatment Technology - Vacuum Mixed Liquor Degassing

(Ref: 11 PL 62AQ 3M12)

Company from north-east Poland developed a technology that can be used to treat wastewater by activated sludge method with biological removal of nitrogen and phosphorus in flow wastewater treatment plant. Technology can be used in wastewater plants, industries that deal with wastewater. The company is interested in manufacturing agreement and commercial agreement with technical assistance with different partners.

Innovative technology line for packaging/repackaging of fertilizers is sought

(Ref: 11 PL 63AW 3M30)

A company from North West Poland is looking for a technology to repackage or package about 15 kg fertilizers' packages into a smaller, moisture resistant packages, between 100g and maximum 3kg. Ideal solution is a small sachet between 200g and 300g, targeted for individual user. Technical cooperation, manufacturing, and commercial agreements are sought.

Novel rainwater harvesting system for restricted space locations

(Ref: 11 IE 51S6 3M4V)

An Irish product development group have designed, prototyped, and applied for patent protection for a rainwater harvesting system. The system is designed specifically to suit urban situations where space is at a premium and traditional water butts and tanks are not suitable. It also has other novel features described in below fields. The developers are seeking licensees with suitable manufacturing capabilities to assist them commercialise their product.

AGRICULTURE & ENVIRONMENT

PS - CIP - ECO-Innovation - Seeking partners for an international Implementation of Innovative Plant Nutrition Technology

(Ref: 11 IL 80ER 3LTH)

An Israeli SME that has developed an innovative, groundbreaking technology for the optimization of plants nutrition and agriculture economy along with remarkable contribution to environment protection by minimizing the contamination of soil and underground water, is looking for partners to join it in constructing a project proposal for the 2011 Eco-Innovation call for proposals. The company is mainly looking for partners that will assist in the further implementation of the system.

Innovative systems and equipment for water aeration

(Ref: 11 PL 63AV 3LZZ)

Company from Poland operating on aeration systems market since 1976 is looking for new technologies which can be more effective and low-cost comparing to already available on market. SME is looking for blowers, diffusers, oxygen generators which can be used in fish farming, wastewater treatment plant (for households and industrial).

Technology for remediation of oil contaminated soil using a natural mineral

(Ref: 11 RU 86FG 3LRK)

A group of researchers from Saratov developed and patented a technology for remediation of oil contaminated soil by means of a natural mineral and biological oil destructors. The technology allows cleaning up contaminated soils and hard surfaces in situ without adding fertilizers needed for biostructure nutrition. The inventors are looking for partners for technical cooperation, joint venture or a commercial agreement with technical assistance.

New method for removal of sulphates from water by chemical precipitation

(Ref: 11 ES 252K 3LSE)

A Catalan (Spanish) SME has developed a new compound to remove sulphates from water solutions by chemical precipitation. This new compound allows the removal of sulphates from water in much lower concentrations than traditional methods. The sludge obtained from water sulphate removal can be reused as technical cement or as coagulant and neutralizer for water treatment. The SME is looking for industrial partners interested in license, technical cooperation or commercial agreement.

Micro-nutrients fertiliser

(Ref: 11 PL 64BH 3L4K)

The company from south-east Poland is dealing with production of highly ecological fertilisers for agricultural industry. Their latest research result is a fertiliser based on micro-nutrients supplemented with copolymers. Solution is highly ecologic (lower doses of fertiliser) and economic (crops grow faster about 30-50%). Technology is field tested with good results. Company is looking for partner able to a technological cooperation for further product research and development.

PS - FP7 - BIOREMEDIATION - Efficient on-site remediation technology for the elimination of soil contaminants, especially chlorinated hydrocarbons

(Ref: 11 HU 5010 3M2F)

A Hungarian research centre intending to submit a proposal to the FP7 Research for the benefit of SMEs, inviting partners to develop an efficient on-site remediation technology for the elimination of soil contaminants, especially chlorinated hydrocarbons. Councils, state institutes or estate developers await which have land that need remediation which could serve as a test site. Local authorities responsible for giving permission for different land remediation methods are also awaited.

Floating Ecological Passive Construction Systems

(Ref: 11 TR 99PD 3LVF)

A Turkish construction company offers floating ecological passive construction systems. The environmental friendly construction systems supply solution to having inadequate land for houses and rising water levels. The company is looking for signing license agreements and / or commercial agreements with technical assistances for generalizing the floating ecological passive construction systems.

Mobile gasification of PAH-polluted wood (PAH = Polycyclic Aromatic Hydrocarbon)

(Ref: 11 FR 38m9 3LVH)

A French company has developed a mobile gasification unit to solve the waste management problem of PAH-polluted wood (PAH = Polycyclic Aromatic Hydrocarbon), like wooden beams on railways (called railway ties) or wooden poles used for telecoms. The French company is open to technical cooperation with industrial waste management companies or industrial gas companies.



AGRICULTURE & ENVIRONMENT

Substrateless technologies, equipment and structures for crop production in greenhouses (aeroponic complexes)

(Ref: 11 RU 86FG 3LVA)

A Russian innovation SME from Kaluga region offers technologies for speed-up intensive crop production without ground and/or substrates, as well as structures /equipment for them. Aeroponic technologies allow for efficient utilization of land, it is power and water saving and environmentally friendly. The company seeks partners for technical cooperation on agricultural field trials and further development of aeroponic models for specific crops.

Biodegradable disinfectant and decontamination agent against organic and microbiological pollution

(Ref: 11 NL 60AH 3LWO)

A Dutch company developed an environmentally friendly disinfectant, based on stabilized hydrogen peroxide, against organic and microbiological pollution. The product is successfully used in the Dutch horticultural sector, also against biofilm in water systems. The company is interested in further internationalization and is seeking contacts with industrial partners focusing on disinfection and decontamination technologies in the framework of commercial agreements with technical assistance.



The presence of biofilm is controlled.

Thermo-mechanical digestion of biogenous refuse for horticulture and agriculture

(Ref: 11 DE 094I 3LRF)

A German medium sized enterprise has developed a technology for thermo-mechanical digestion of biogenous refuse. The system is a well-tryed and successful system and gives the end-product special properties thanks to which a wide range of qualitatively different products can be made. The company is looking for industrial partners able to implement the system and for several new applications, e.g. in the building construction sector.



Instantly dense natural fence and noise barrier along roads, terrains and gardens

(Ref: 11 NL 60AH 3LSZ)

A Dutch SME is specialized in so called natural green fences. The prefabricated elements are very easy to place and couple and are very appropriate as noisebarriers along roads, public areas, gardens etc. The company is looking for partners in the field of contracting, designing and organizing of infrastructural projects and landscapes, especially when noise problems have to be solved. The offer can also be interesting for suppliers, architects and producers active in this sector.



Modular designed container with digestion technology for biogas plants for increasing in biogas productivity til 35%

(Ref: 11 DE 094I 3LTK)

A German company has developed a container with digestion technology for biogas plant. The advantage of the technology is the increase in biogas productivity and the possibility of inserting diverse materials into the biogas plant via bioextrusion. Under the slogan: "Together we can expand your existing biogas plant or design a new one" the company is seeking industrial partners for further development and/or a commercial agreement with technical assistance.



Biomass Co-Generation Plant (CHP) with Electrical Output of 100kW

(Ref: 11 DE 1486 3KWT)

A German engineering company (30 employees), located close to Munich Airport, is offering turn-key plants for cogeneration of heat and power from biomass. The core product Biomass Heatpipe-Reformer (BioHPR) uses fluidized-bed technology for biomass gasification and a micro gas turbine for power generation. The technology enables low operation costs and high efficiency at the same time. BioHPR is already on the market. Interest: joint venture, commercial agreement with technical assistance.

Biogas plants and installations - providers of suitable technology are sought

(Ref: 11 PL 63AZ 3LNY)

Polish company is looking for partners able to provide technologies within biogas plants and installations. The company is searching for providers of suitable technology for establishing a biogas plant. The technology should be already introduced to the market or in laboratory stage but ready for implementation. The company is searching for partners for manufacturing and/or commercial agreement with technical assistance.

Use of ocean wave power as a renewable energy production for an offshore aquaculture facility

(Ref: 11 ES 27F4 3LSB)

An Andalusian aquaculture organization is looking for a system that allows the use of the waves that occurs on the offshore aquaculture facility surroundings as a source of power generation, clean and renewable, that will contribute to the environmental sustainability of the aquaculture activity by the use of a sustainable energy source. They are interested in signing a cooperation agreement with other companies or research centres in order to develop this technology at a pilot scale.

Hybrid helio-wind power plant of 0.1 KWatt installed power

(Ref: 11 RU 86FG 3LRM)

A small Russian company working in the field of energy saving developed a hybrid helio-wind power plant for producing electric energy. The portable power plant has integrated solar panels; it can be applied for public or individual lighting, operation of low-powered electric devices. The company seeks partners for further development of the technology and adaptation to specific needs.

Innovative Energy Fence as an energy source for residential heat pumps

(Ref: 11 FR 34K2 3LPU)

A French SME, in the industrial field of thermodynamics, has developed and patented a technology to collect energy with fence panels for residential geothermal/solar heat pumps. The fence captures the three natural energy sources (solar, rain and air). This is a new simple and cost-effective solution for residential heating. The SME seeks industrial manufacturers (heat pumps, capture buried) wishing to integrate the product in their range to expand into new markets under license/comm agreements.

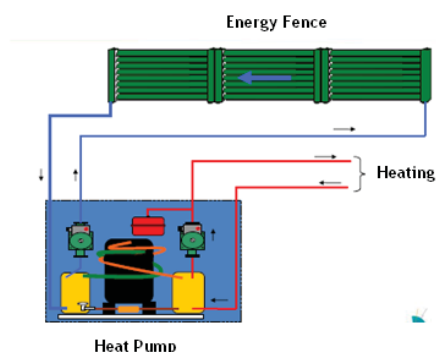

Technology of methane, electric and heat energy production on the basis of dry sawdust and biogas

(Ref: 11 PL 62AP 3LS1)

A Polish producer of laminated wood is looking for a technology of methane, electric and heat energy production on the basis of dry sawdust and biogas (small, mobile biomethane power plant). Technology should use for production process as raw material - sawdust with a natural moisture content of 12-18%. The company is looking for a partner for license/commercial agreement with technical assistance.

Central heating boiler body welding

(Ref: 11 PL 64BD 3L2E)

An enterprise from Poland, operating in production of heating boilers since 1994 is looking for an innovative low-cost welding technology to eliminate leakage of boilers. The sought technology should be available on the market at least for five years and should have EU patent. The company is looking for partners for technical cooperation, commercial agreement with technical assistance.

Hybrid and Organic Photovoltaic Technologies

(Ref: 11 IT 55X8 3M0H)

An Italian SME has developed a Dye Solar Cell and polymer photovoltaic technologies. These technologies allow for easy integration in portable electronics and buildings, enabling applications that are not possible with traditional photovoltaics. The competitive cost of materials and processing, increases the appeal of such devices. The company is looking for partners for technical cooperation or commercial agreement with technical assistance.

Low cost hydrogen production

(Ref: 11 IL 80EP 3LV2)

An Israeli team has developed a method for cheap and instant production of hydrogen that can be used for car refilling stations. The team is interested in licensing or finding a strategic R&D and/or a Financial partner to assist bringing the technology to market.

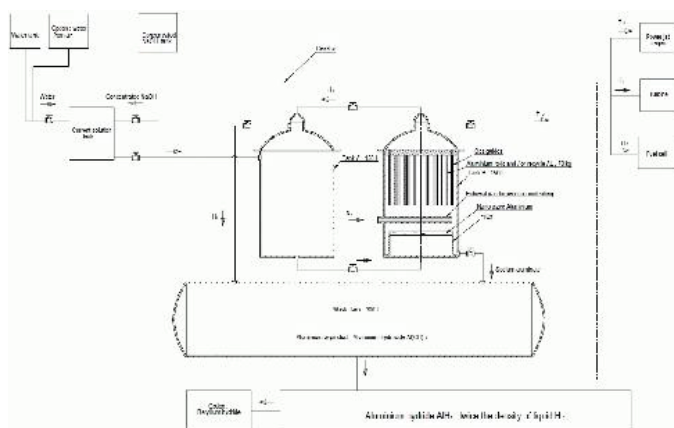

Technology of effective production of ethanol fuel - technology request, R&D Partner sought

(Ref: 10 PL 63AU 3JVI)

The request concerns the R&D of new non-typical materials and microorganisms to be used during the production of ethanol fuel. The research party located at the Lower Silesian (Poland) University would like to focus on material characteristics, optimization of fermentation process, but also designating the conditions and microorganisms for the most suitable production environment. The research party seeks R&D partners willing to cooperate on joint-initiative or licensing basis.

Environmentally friendly technology for receiving thermal energy from biomass

(Ref: 11 PL 63AV 3M6O)

Small enterprise from Poland is offering environmentally friendly and low - cost technology for central heating or to generate thermal energy. The fuel is wet biomass that could be compost, all kind of wood, straw, tires etc. Because of underpressure pyrolysis process there is a minimal emission of gasses. The technology is fully developed and tested by clients. Company is looking for technical cooperation or licence agreement with companies from foreign countries. SME offers technology support.

Innovative and highly efficient technology for generating electric energy from biomass

(Ref: 11 PL 63AV 3M6Y)

Company from Poland specialized in vacuum pyrolysis process is looking for investor. Company has developed very efficient and innovative technology for generating electric energy from biomass. SME needs investor who will pay for building prototype of engine which converts thermal energy generating from pyrolysis into electric energy. Company wants to establish new joint venture company with investor.

Pendular wind turbine

(Ref: 11 ES 29G6 3M69)

A Spanish industrial engineering SME focused on wind energy has designed, developed and patented a pendular wind turbine. This innovative wind turbine compensates, accumulates and reinstates the variations caused by wind gusts, with three passive mechanical systems that mitigate the peak power and structural overloads. This system reduces the stress in the turbine components and improves its functioning. The company will study many different types of agreements with interested partners.



Technology line for production of pellets is sought

(Ref: 11 PL 64BH 3M52)

The company from south-east Poland dealing with biological waste recycling is looking for modern and efficient technology line for production of pellets from straw, hay and sawdust. The technology requested can either be at the laboratory stage or fully developed. Commercial agreement with technical support is sought.

A large, white, stylized letter 'C' is centered on the page. It is a thick, curved shape that is open on the right side. The text 'FIND NEW INTERNATIONAL BUSINESS PARTNERS' is written in a dark grey, sans-serif font across the middle of the 'C'.

FIND NEW INTERNATIONAL BUSINESS PARTNERS



What is matchmaking?

Matchmaking in the business sector, is all about getting a lot of different companies and organisations from a particular sector to meet at a matchmaking event, and to help them create new national and international working relationships.

During these matchmaking meetings, which can be run over 1-2 days, participants can meet new potential business partners. Meetings are normally arranged in advance, and can typically last for 30 minutes, which is enough to see if there is the potential for future co-operation. Matchmaking is the quickest and cheapest way to build up new contacts in other countries.

Most matchmaking events are held in connection with international trade fairs and give your company the chance to meet with other businesses relevant for you – whether your visit is to buy, sell or simply to learn about new technologies.

There are many matchmaking events in Europe and a small selection is shown in this edition of TechMatch. If you want to hear more about an event, or wish to take part, please contact one of our consultants.

International Matchmaking Events

Energy is Future 2011

"International Electricity Summit/EIF 2011" is a platform in which many different topics concerning electricity generation in Turkey and all around the World will be discussed. The purpose of the congress which will be held with supports of Republic of Turkey Ministry of Energy and Natural Resources is to evaluate different electricity generation sources multi-faceted and to create an atmosphere in which latest developments and applications could be discussed and handled in every detail.

Throughout this conference, a brokerage event between domestic and foreign companies will be organised with supports of Technology Development Foundation of Turkey; a partner of Europe Enterprise Network- BSN Anatolia Consortium and Republic of Turkey Prime Ministry Investment Support and Promotion Agency.

Congress will be held in Ankara Sheraton Hotel & Convention Center from 14 to 16 September 2011. Representatives of many national and international energy companies and also many academicians, bureaucrats and representatives of non-governmental organizations will attend to the congress.

Further Information and Online Registration

<http://www.energy-congress.com/>



INTERNATIONAL ELECTRICITY SUMMIT
14 - 15 - 16 SEPTEMBER 2011

Date:

14-16 September 2011

City/country:

Ankara, Turkey

Sectors:

Energy

Registration:

2 September 2011

SPACE 2011 - Livestock brokerage event

A Brokerage Event will be held on the occasion of the SPACE exhibition in Rennes, France from the 14th to the 15th of September 2010. The possibility for the exhibitors and the visitors to meet face to face during planned meetings (30 mn) for commercial or technological partnerships.

With 107 327 visitors in 2010 the SPACE exhibition is the essential international show for livestock professionals in every sector: cattle (dairy and beef), pigs, poultry, rabbits, sheep and goats.

SECTORS MOST REPRESENTED BY EXHIBITORS:

- Animal feed
- Livestock buildings
- Livestock equipment
- Breeding, artificial insemination, hatcheries
- Handling, loading and transport on the farm
- Treating farm effluent
- Animal health
- Agri-energy
- Milking equipment
- Water treatment
- Seeds

Further Information

<http://uk.space.fr>

**Date:**

14-15 September 2011

City/country:

Rennes, France

Sectors:

Agriculture - Forestry
Veterinary
Food - Agro Industry

Registration:

International Matchmaking Events

ANUGA Matchmaking

Over 6,500 exhibitors and around 150,000 trade visitors. Almost 300,000 m² of inspiration, ideas and innovations. ANUGA is not only the largest food and beverage fair in the world; it's also the sector's most important fair for new markets and target groups.

In order to help small and medium-sized companies make full use of this potential to find business, technology or research partners, Enterprise Europe Network organises a Matchmaking Event from October 10th - 11th. The Matchmaking will be open to all sub-sectors of the food industry.

Why participate in a Matchmaking Event?

- You meet committed potential business partners – and we arrange the meetings for you!
- You choose your meeting partners at your desk (at home). Your choice is based on concise company profiles.
- We offer you support before, during and after the event, e.g. by helping you to formulate an informative cooperation profile or accompanying you to your meeting.
- This way, you can make better use of your time at the exhibition.

Further Information

<http://www.b2match.eu/anuga2011/>

**Date:**

10-11 October 2011

City/country:

Cologne, Germany

Sectors:

Agrofood

Registration:

16 September 2011

RIGA FOOD brokerage event

RIGA FOOD 2011 is the 16th International Trade Fair For Food Industry, Drinks, Food Processing Technology and Packing International Food Competition.

In 2010 more than 550 exhibitors from 35 countries participated in RIGA FOOD, and more than 35,000 visitors were registered.

This year there is an opportunity to participate in a Brokerage Event organised by Enterprise Europe Network Latvia (Latvian Technological Centre), and kindly hosted by BT1. Also other Enterprise Europe Network nodes are invited to be co-organisers of this event. The Brokerage Event will enable its participants to make fruitful contacts with potential business and research partners from all over Europe, especially Baltic countries.

Participants are invited to publish their technology profiles in an online catalogue. Individual bilateral meetings will be booked in advance and will be pre-arranged and assisted by Enterprise Europe Network Latvia staff.

Who should attend the event?

- Small and medium-sized enterprises, offering or using new technologies.
- Researchers/developers of innovative technologies.

Further Information and Registration

<http://www.bt1.lv/bt1/rigafood/?link=10000000>

**Date:**

9 September 2011

City/country:

Riga, Latvia

Sectors:

Agricultural and marine resources and products

Registration:

A large, white, stylized letter 'H' is centered on the page. The 'H' is composed of two vertical bars and a horizontal bar connecting them in the middle. The text 'TECHMATCH IS PRODUCED BY' is written in a dark grey, sans-serif font across the horizontal bar of the 'H'.

TECHMATCH IS PRODUCED BY

EDITORIAL

TechMatch is produced by Agro Business Park, on behalf of the Enterprise Europe Network in the Nordic regions.



AGRO
BUSINESS
PARK

Niels Pedersens Allé 2
DK-8830 Tjele

Tel: +45 8999 2500
Fax: +45 8999 2599
info@agropark.dk
www.agropark.dk

Editorial staff:



Simon Poulsen
Agro Business Park
Tel: +45 8999 2501
sp@agropark.dk



Mette Toft Christensen
Agro Business Park
Tel: +45 8999 2503
mtc@agropark.dk

Facts about Enterprise Europe Network

Who are we?

- 580 organisations
- 5000 experienced personnel
- Activities in 48 countries

How can we help you?

- We can help your company find relevant trading partners
- We help SMEs develop new products, open new markets and provide information on EU opportunities
- We advise SMEs on technical issues including IPR, standards and EU legislation
- We operate as an intermediary between entrepreneurs and EU decision makers and can help your company be heard in Europe



Business Support at Your Doorstep

www.enterprise-europe-network.ec.europa.eu